

## □ General Description

BYD IGBT Power Module BG25G12H13L4-L provides low switching losses characteristic as well as high power and thermal cycling capability, which introduce the advanced IGBT chip/FWD and improved connection.

## □ 概述

BYD IGBT 功率模块 BG25G12H13L4-L 采用高性能的 IGBT 芯片和 FRD 芯片和优化的电气连接，具有低开关损耗和高功率循环和温度循环能力。



$$V_{CES}=1200V, I_C=25A$$

## □ Key Features

- 1200V planar field-stop technology
- Low conduction and switching losses
- $V_{CESat}$  with positive temperature coefficient
- Low  $V_{CESat}$

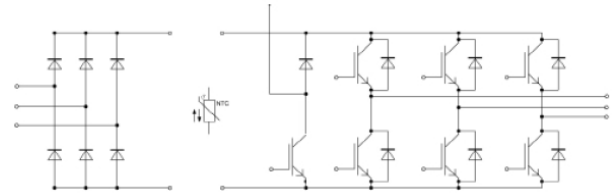

## □ 关键特性

- 1200V 平面栅场终止技术
- 低导通和开关损耗
- $V_{CESat}$  正温度系数
- 低  $V_{CESat}$

## □ Applications

- Auxiliary Inverters
- Servo drives
- Motor drives

## □ 应用

- 辅助逆变器
- 伺服驱动器
- 电机传动



□ IGBT, 逆变器/ IGBT, Inverter

● Maximum Rated Values/最大额定值

Symbol	Items	Conditions	Values	Units
$V_{CES}$	Collector-emitter voltage 集电极-发射极电压	$T_{vj}=25^{\circ}\text{C}$	1200	V
$I_C$	Collector current 连续集电极直流电流	$T_C=100^{\circ}\text{C}$ , $T_{vj\max}=175^{\circ}\text{C}$	25	A
$V_{GES}$	Gate-emitter voltage 栅极-发射极峰值电压		$\pm 20$	V
$I_{CRM}$	Repetitive peak collector current 集电极重复峰值电流	$t_p=1\text{ms}$	50	A
$P_{tot}$	Total power dissipation 总功率损耗	$T_C=25^{\circ}\text{C}$ , $T_{vj\max}=175^{\circ}\text{C}$	175	W

● Characteristics Values/特征值

Symbol	Items	Conditions	Values			Units	
			Min.	Typ.	Max.		
$V_{CESat}$	Collector-Emitter Saturation Voltage 集电极-发射极饱和电压	$I_C=25\text{A}, V_{GE}=15\text{V}, T_{vj}=25^{\circ}\text{C}$	1.8	2.1	2.3	V	
		$I_C=25\text{A}, V_{GE}=15\text{V}, T_{vj}=125^{\circ}\text{C}$	-	2.3	-	V	
		$I_C=25\text{A}, V_{GE}=15\text{V}, T_{vj}=150^{\circ}\text{C}$	-	2.5	-	V	
$V_{GETh}$	Gate threshold voltage 栅极阈值电压	$V_{CE}=V_{GE}, I_C=1.6\text{mA}, T_{vj}=25^{\circ}\text{C}$	4.8	5.8	6.9	V	
$Q_G$	Gate charge 栅极电荷	$V_{GE}=-8\text{V}\dots+15\text{V}$	-	0.22	-	$\mu\text{C}$	
$R_{Gint}$	Internal gate resistance 内部栅极电阻	$T_{vj}=25^{\circ}\text{C}$	-	12	-	$\Omega$	
$C_{ies}$	Input capacitance 输入电容	$T_{vj}=25^{\circ}\text{C}, f=1\text{MHz}, V_{GE}=0\text{V}, V_{CE}=25\text{V}$	-	1.78	-	nF	
$C_{res}$	Reverse capacitance 反向传输电容		-	0.06	-	nF	
$I_{CES}$	Collector-emitter cut-off current 集电极-发射极截止电流	$V_{CE}=1200\text{V}, V_{GE}=0\text{V}, T_{vj}=25^{\circ}\text{C}$	-	-	0.5	mA	
$I_{GES}$	Gate-emitter leakage current 栅极-发射极漏电流	$V_{CE}=0\text{V}, V_{GE}=20\text{V}, T_{vj}=25^{\circ}\text{C}$	-	-	200	nA	
$t_{don}$	Turn-on delay time 开通延迟时间	$I_C = 25\text{A},$ $V_{CE} = 600\text{V},$ $V_{GE}=-8\text{V}\dots+15\text{V},$ $R_{Gon} = R_{Goff} = 13\Omega$	$T_{vj}=25^{\circ}\text{C}$	-	66	-	ns
			$T_{vj}=125^{\circ}\text{C}$	-	67	-	ns
			$T_{vj}=150^{\circ}\text{C}$	-	68	-	ns
$t_r$	Rise time 上升时间		$T_{vj}=25^{\circ}\text{C}$	-	65	-	ns
			$T_{vj}=125^{\circ}\text{C}$	-	71	-	ns
			$T_{vj}=150^{\circ}\text{C}$	-	73	-	ns



## BG25G12H13L4-L

$t_{d\ off}$	Turn-off delay time 关断延迟时间		$T_{vj}=25^{\circ}C$	-	109	-	ns
			$T_{vj}=125^{\circ}C$		117		ns
			$T_{vj}=150^{\circ}C$	-	128	-	ns
$t_f$	Fall time 下降时间		$T_{vj}=25^{\circ}C$	-	53	-	ns
			$T_{vj}=125^{\circ}C$		224		ns
			$T_{vj}=150^{\circ}C$	-	273	-	ns
$E_{on}$	Turn-on energy loss 开通损耗能量		$T_{vj}=25^{\circ}C$	-	2.51	-	mJ
			$T_{vj}=125^{\circ}C$		2.89		mJ
			$T_{vj}=150^{\circ}C$	-	3.18	-	mJ
$E_{off}$	Turn-off energy loss 关断损耗能量		$T_{vj}=25^{\circ}C$	-	1.08	-	mJ
			$T_{vj}=125^{\circ}C$		1.48		mJ
			$T_{vj}=150^{\circ}C$	-	1.55	-	mJ
$I_{sc}$	SC data 短路数据	$V_{GE} \leq 15V, V_{CC}=800V, V_{CE\ max} = V_{CES} - L_{sCE} \cdot di/dt$ $t_p \leq 10\mu s$	$T_{vj}=150^{\circ}C$		100		A
$R_{thJC}$	Thermal resistance, junction to case 结-外壳热阻	每个 IGBT / per IGBT				0.85	K/W
$T_{vj\ op}$	Temperature under switching conditions 在开关状态下温度			-40		150	$^{\circ}C$

### □ FRD, 逆变器/ Diode, Inverter

#### ● Maximum Rated Values/最大额定值

Symbol	Items	Conditions	Values	Units
$V_{RRM}$	Repetitive peak reverse voltage 反向重复峰值电压	$T_{vj} = 25^{\circ}C$	1200	V
$I_F$	Forward current of diode 连续正向直流电流		25	A
$I_{FRM}$	Repetitive peak forward current 正向重复峰值电流	$t_p = 1ms$	50	A
$I^2t$	$I^2t$ - value $I^2t$ -值	$V_R = 0V, t_p = 10ms, T_{vj} = 150^{\circ}C$	244	$A^2S$

#### ● Characteristics Values/特征值

Symbol	Items	Conditions	Values			Units	
			Min.	Typ.	Max.		
$V_F$	Forward voltage 正向电压	$I_F=25A,$ $V_{GE}=0V$	$T_{vj}=25^{\circ}C$	1.51	1.87	2.03	V
			$T_{vj}=125^{\circ}C$		1.78		V
			$T_{vj}=150^{\circ}C$	-	1.73	-	V



## BG25G12H13L4-L

I <sub>RM</sub>	Peak reverse recovery current 反向恢复峰值电流	I <sub>F</sub> = 25 A, - di <sub>F</sub> /dt = 900 A/μs (T <sub>vj</sub> =150°C) V <sub>R</sub> = 600 V V <sub>GE</sub> = -8 V	T <sub>vj</sub> =25°C	-	8.5	-	A
			T <sub>vj</sub> =125°C		12.0		A
			T <sub>vj</sub> =150°C		12.2		A
Q <sub>r</sub>	Recovered charge 恢复电荷		T <sub>vj</sub> =25°C	-	0.42	-	μC
			T <sub>vj</sub> =125°C		2.57		μC
			T <sub>vj</sub> =150°C		3.15		μC
E <sub>rec</sub>	Reverse recovery energy 反向恢复损耗		T <sub>vj</sub> =25°C	-	1.08	-	mJ
			T <sub>vj</sub> =125°C		1.26		mJ
			T <sub>vj</sub> =150°C		1.45		mJ
R <sub>thJC</sub>	Thermal resistance, junction to case 结-外壳热阻	每个二极管 / per diode				1.3	K/W
T <sub>vj op</sub>	Temperature under switching conditions 在开关状态下温度			-40		150	°C

### □ FRD, 整流管/ Diode, Rectifier

#### ● Maximum Rated Values/最大额定值

Symbol	Items	Conditions	Values	Units
V <sub>RRM</sub>	Repetitive peak reverse voltage 反向重复峰值电压	T <sub>vj</sub> = 25°C	1600	V
I <sub>FRMSM</sub>	Maximum RMS forward current per chip 最大正向均方根电流(每芯片)	T <sub>C</sub> = 85°C	25	A
I <sub>RMSM</sub>	Maximum RMS current at rectifier output 最大整流器输出均方根电流	T <sub>C</sub> = 85°C	25	A
I <sub>FSM</sub>	Repetitive peak forward current 正向浪涌电流	t <sub>p</sub> =10ms, T <sub>vj</sub> = 25°C	410	A
		t <sub>p</sub> =10ms, T <sub>vj</sub> = 150°C	330	A
I <sup>2</sup> t	I <sup>2</sup> t - value I <sup>2</sup> t-值	t <sub>p</sub> = 10 ms, T <sub>vj</sub> = 25°C	840	A <sup>2</sup> S
		t <sub>p</sub> = 10 ms, T <sub>vj</sub> = 150°C	544	A <sup>2</sup> S

#### ● Characteristics Values/特征值

Symbol	Items	Conditions	Values			Units	
			Min.	Typ.	Max.		
V <sub>F</sub>	Forward voltage 正向电压	I <sub>F</sub> =25A	T <sub>vj</sub> =150°C	-	1	1.2	V
I <sub>R</sub>	Reverse current 反向电流	V <sub>R</sub> =1600V	T <sub>vj</sub> =25°C	-	5	-	μA
			T <sub>vj</sub> =150°C		0.5	1	mA
R <sub>thJC</sub>	Thermal resistance,5 junction to case 结-外壳热阻	每个二极管 / per diode				0.83	K/W



$T_{vj\ op}$	Temperature under switching conditions 在开关状态下温度			-40		150	$^{\circ}\text{C}$
--------------	--	--	--	-----	--	-----	--------------------

**IGBT, 制动-斩波器/IGBT, Brake-Chopper**

**Maximum Rated Values/最大额定值**

Symbol	Items	Conditions	Values	Units
$V_{CES}$	Collector-emitter voltage 集电极-发射极电压	$T_{vj}=25^{\circ}\text{C}$	1200	V
$I_{C\ nom}$	Collector current	$T_C=100^{\circ}\text{C}, T_{vj\ max}=175^{\circ}\text{C}$	25	A
$I_C$	连续集电极直流电流	$T_C=25^{\circ}\text{C}, T_{vj\ max}=175^{\circ}\text{C}$	50	A
$V_{GES}$	Gate-emitter voltage 栅极-发射极峰值电压		$\pm 20$	V
$I_{CRM}$	Repetitive peak collector current 集电极重复峰值电流	$t_p=1\text{ms}$	50	A
$P_{tot}$	Total power dissipation 总功率损耗	$T_C=25^{\circ}\text{C}, T_{vj\ max}=175^{\circ}\text{C}$	175	W

**Characteristics Values/特征值**

Symbol	Items	Conditions	Values			Units	
			Min.	Typ.	Max.		
$V_{CEsat}$	Collector-Emitter Saturation Voltage	$I_C=25\text{A}, V_{GE}=15\text{V}, T_{vj}=25^{\circ}\text{C}$	1.8	2.1	2.3	V	
	集电极-发射极饱和电压	$I_C=25\text{A}, V_{GE}=15\text{V}, T_{vj}=150^{\circ}\text{C}$	-	2.5	-	V	
$V_{GEth}$	Gate threshold voltage 栅极阈值电压	$V_{CE}=V_{GE}, I_C=1\text{mA}, T_{vj}=25^{\circ}\text{C}$	4.8	5.8	6.9	V	
$Q_G$	Gate charge 栅极电荷	$V_{GE}=-8\text{V}\dots+15\text{V}$	-	0.22	-	$\mu\text{C}$	
$R_{Gint}$	Internal gate resistance 内部栅极电阻	$T_{vj}=25^{\circ}\text{C}$	-	12	-	$\Omega$	
$C_{ies}$	Input capacitance 输入电容	$T_{vj}=25^{\circ}\text{C}, f=1\text{MHz}, V_{GE}=0\text{V}, V_{CE}=25\text{V}$	-	1.78	-	nF	
$C_{res}$	Reverse capacitance 反向传输电容		-	0.06	-	nF	
$I_{CES}$	Collector-emitter cut-off current 集电极-发射极截止电流	$V_{CE}=1200\text{V}, V_{GE}=0\text{V}, T_{vj}=25^{\circ}\text{C}$	-	-	50	$\mu\text{A}$	
$I_{GES}$	Gate-emitter leakage current 栅极-发射极漏电流	$V_{CE}=0\text{V}, V_{GE}=20\text{V}, T_{vj}=25^{\circ}\text{C}$	-	-	200	nA	
$t_{d\ on}$	Turn-on delay time 开通延迟时间	$I_C = 25\text{A},$	$T_{vj}=25^{\circ}\text{C}$	-	66	-	ns
		$V_{CE} = 600\text{V},$	$T_{vj}=150^{\circ}\text{C}$	-	68	-	ns



## BG25G12H13L4-L

$t_r$	Rise time 上升时间	$V_{GE} = -8V \dots +15V$ , $R_{Gon} = R_{Goff} = 13\Omega$	$T_{vj} = 25^\circ C$	-	65	-	ns
			$T_{vj} = 150^\circ C$	-	73	-	ns
$t_{d\ off}$	Turn-off delay time 关断延迟时间		$T_{vj} = 25^\circ C$	-	109	-	ns
			$T_{vj} = 150^\circ C$	-	128	-	ns
$t_f$	Fall time 下降时间		$T_{vj} = 25^\circ C$	-	53	-	ns
			$T_{vj} = 150^\circ C$	-	273	-	ns
$E_{on}$	Turn-on energy loss 开通损耗能量		$T_{vj} = 25^\circ C$	-	2.51	-	mJ
			$T_{vj} = 150^\circ C$	-	3.18	-	mJ
$E_{off}$	Turn-off energy loss 关断损耗能量	$T_{vj} = 25^\circ C$	-	1.08	-	mJ	
		$T_{vj} = 150^\circ C$	-	1.55	-	mJ	
$I_{sc}$	SC data 短路数据	$V_{GE} \leq 15V$ , $V_{CC} = 800V$ , $V_{CEmax}$ $= V_{CES} - L_{sCE} \cdot di/dt$ $t_p \leq 10\mu s$	$T_{vj} = 150^\circ C$		100		A
$R_{thJC}$	Thermal resistance, junction to case 结-外壳热阻	每个 IGBT / per IGBT				0.85	K/W
$T_{vj\ op}$	Temperature under switching conditions 在开关状态下温度			-40		150	$^\circ C$

### FRD, 制动-斩波器/Diode, Brake-Chopper

#### Maximum Rated Values/最大额定值

Symbol	Items	Conditions	Values	Units
$V_{RRM}$	Repetitive peak reverse voltage 反向重复峰值电压	$T_{vj} = 80^\circ C$	1200	V
$I_F$	Forward current of diode 连续正向直流电流		25	A
$I_{FRM}$	Repetitive peak forward current 正向重复峰值电流	$t_p = 1ms$	50	A
$I^2t$	$I^2t$ - value $I^2t$ -值	$V_R = 0V$ , $t_p = 10ms$ , $T_{vj} = 125^\circ C$	244	A <sup>2</sup> S

#### Characteristics Values/特征值

Symbol	Items	Conditions	Values			Units	
			Min.	Typ.	Max.		
$V_F$	Forward voltage 正向电压	$I_F = 25A$ , $V_{GE} = 0V$	$T_{vj} = 25^\circ C$	1.8	1.9	2.3	V
			$T_{vj} = 150^\circ C$	-	1.87	-	V
$I_{RM}$	Peak reverse recovery current 反向恢复峰值电流	$I_F = 25A$ , - $di_F/dt$ $= 900A/\mu s$ ( $T_{vj} = 150^\circ C$ )	$T_{vj} = 25^\circ C$	-	12	-	A
			$T_{vj} = 150^\circ C$		12.2		A



## BG25G12H13L4-L

Q <sub>r</sub>	Recovered charge 恢复电荷	V <sub>R</sub> = 600 V	T <sub>vj</sub> =25°C	-	2.1	-	uC
	E <sub>rec</sub>		Reverse recovery energy 反向恢复损耗	T <sub>vj</sub> =150°C		4.3	
			T <sub>vj</sub> =25°C	-	1.26	-	mJ
			T <sub>vj</sub> =150°C		1.45		mJ
R <sub>thJC</sub>	Thermal resistance, junction to case 结-外壳热阻	每个二极管 / per diode				1.3	K/W
T <sub>vj op</sub>	Temperature under switching conditions 在开关状态下温度			-40		150	°C

### □ NTC-Thermistor/负温度系数热敏电阻

Parameter 额定电阻值	Symbol	Conditions	Values			Units
			Min.	Typ.	Max.	
Rated resistance 额定电阻值	R <sub>25</sub>	T <sub>C</sub> =25°C	-	5.0	-	kΩ
Deviation of R100 R100 偏差	ΔR/R	T <sub>C</sub> =100°C, R <sub>100</sub> =493Ω	-5	-	5	%
Power dissipation 耗散功率	P <sub>25</sub>	T <sub>C</sub> =25°C	-	-	20	mW
B-value/B-值	B <sub>25/50</sub>	$R_2=R_{25}\exp[B_{25/50}(1/T_2-1/(298.15K))]$	-	3375	-	K
B-value/ B-值	B <sub>25/80</sub>	$R_2=R_{25}\exp[B_{25/80}(1/T_2-1/(298.15K))]$	-	3411	-	K
B-value/ B-值	B <sub>25/100</sub>	$R_2=R_{25}\exp[B_{25/100}(1/T_2-1/(298.15K))]$	-	3433	-	K

### □ Module/模块

Symbol	Items	Conditions	Values			Units
			Min.	Typ.	Max.	
T <sub>vj max</sub>	Maximum junction temperature 最大结温	逆变器, 制动-斩波器 /inverter,brake-chopper	175			°C
		整流器/rectifier	150			
T <sub>vj op</sub>	Temperature under switching conditions 工作结温	-	-40	-	150	°C
T <sub>stg</sub>	Storage temperature 储存温度	-	-40	-	125	°C
CT1	Comperative tracking index 相对电痕指数			> 200		
R <sub>thCH</sub>	Thermal resistance, Case to heatsink 外壳-散热器热阻	每个模块 / per module $\lambda_{\text{Paste}} = 1 \text{ W}/(\text{m}\cdot\text{K}) / \lambda_{\text{grease}}$ $= 1 \text{ W}/(\text{m}\cdot\text{K})$	-	0.03	-	K/W
L <sub>sCE</sub>	Stray inductance module 杂散电感, 模块		-	35	-	nH



## BG25G12H13L4-L

V <sub>ISOL</sub>	Isolation test voltage 绝缘测试电压	f = 50Hz, t = 1min.		2.5	-	kV
G	Weight 重量	-	-	180	-	g
-	Cree page distance 爬电距离	Terminal to terminal 端子到端子	-	10	-	mm
-		Terminal to base 端子到底板	-	10	-	
-	Clearance distance in air 空气间隙	Terminal to terminal 端子到端子	-	7.5	-	
-		Terminal to base 端子到底板	-	7.5	-	
M	Mounting torque for module mounting 模块的安装扭矩	Screw M5 M5 螺栓	3.0	-	6.0	Nm
-	Internal isolation 内部绝缘	ceramics 陶瓷	Al <sub>2</sub> O <sub>3</sub>			-
-	Material of module baseplate 模块基板材料	-	Cu			-
L x W x H	Dimensions 尺寸	-	107.5x 45 x 20.5			mm



□ Characteristics Diagrams/特性曲线

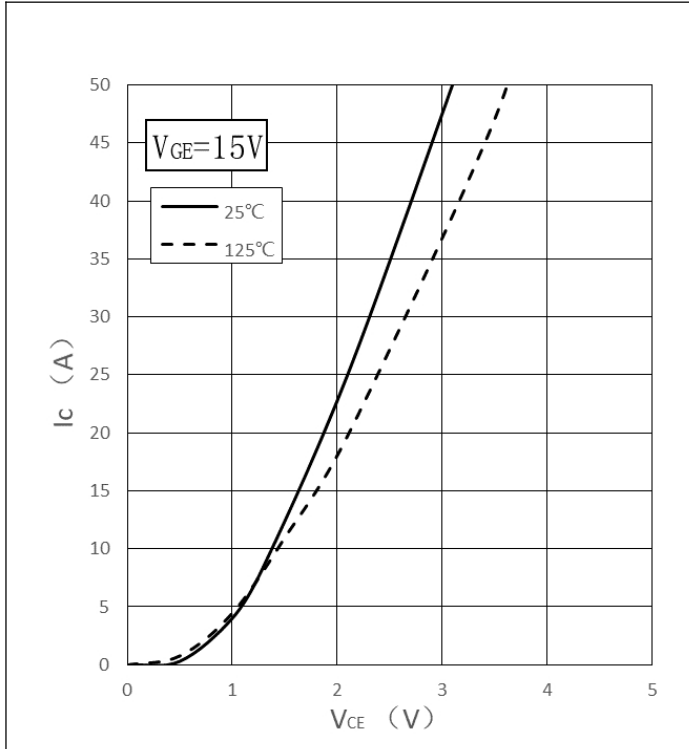

Fig.1 Typ. Output Characteristics-Inverter

图 1 输出特性-逆变器

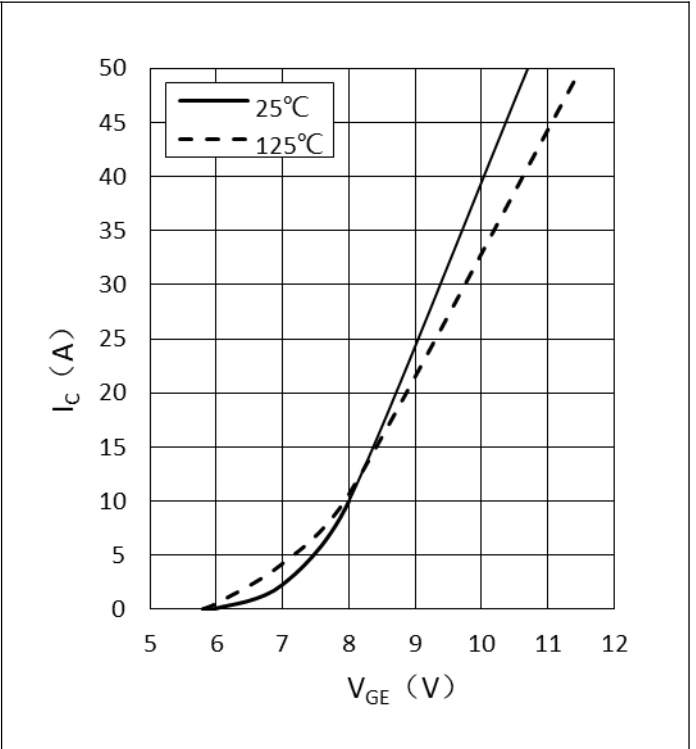

Fig.2 Typ. Transfer Characteristics-Inverter

图 2 传输特性-逆变器

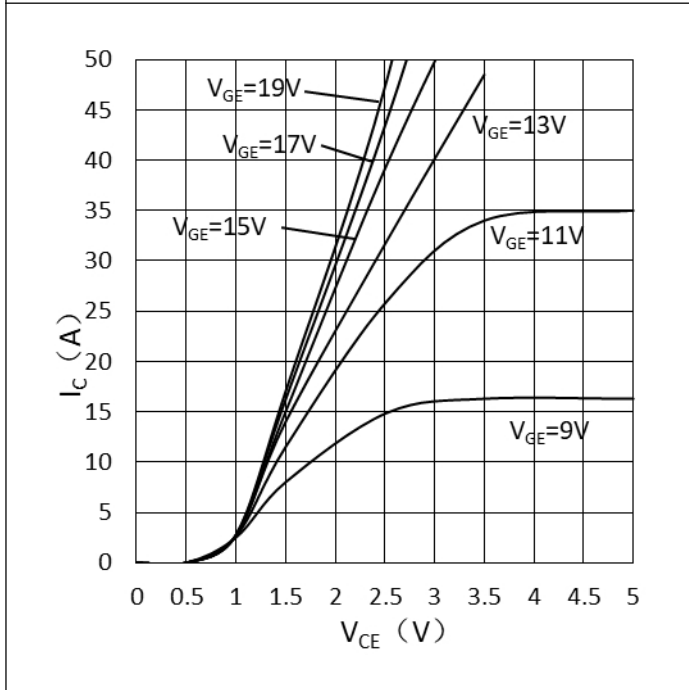

Fig.3 Typ. Output Characteristics-Inverter

图 3 输出特性-逆变器

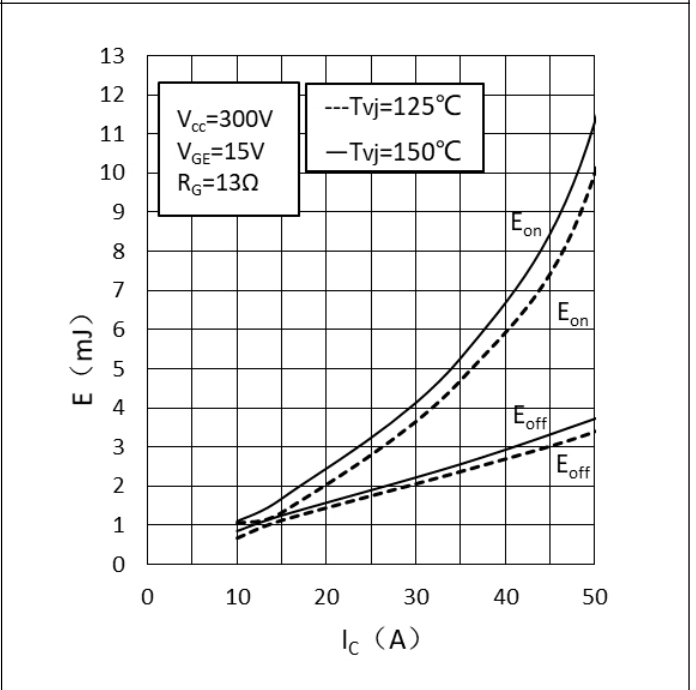

Fig.4 Switching Loss vs. Collector Current-Inverter

图 4 开关损耗和集电极电流-逆变器

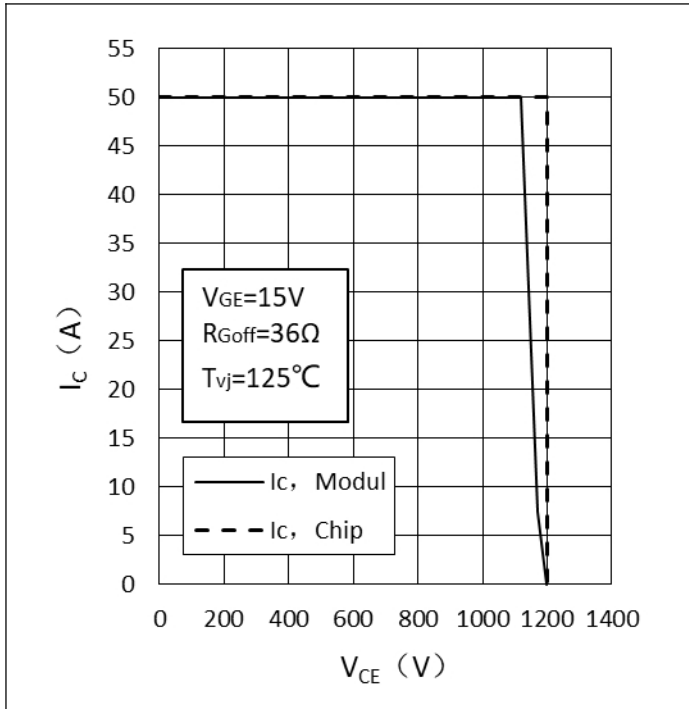

Fig.5 Reverse Bias Safe Operating Area (RBSOA)  
-Inverter

图 5 反偏安全工作区-逆变器

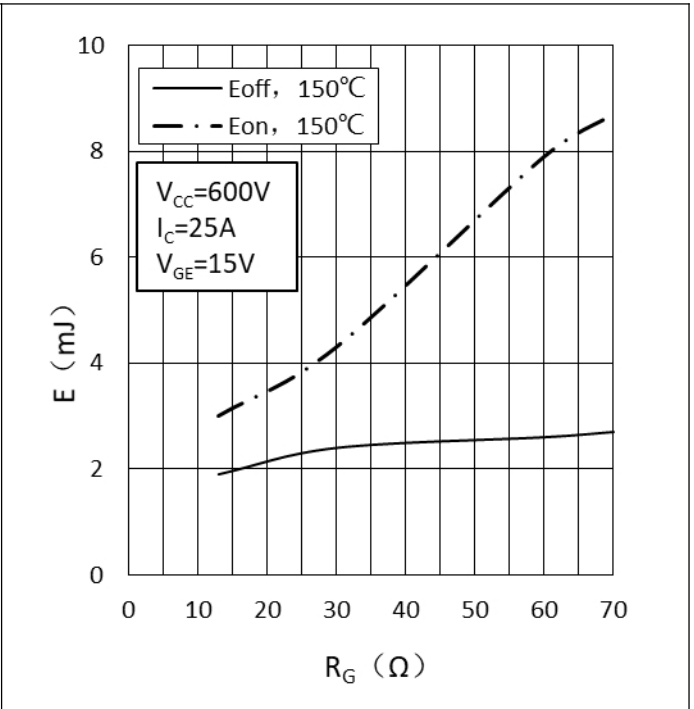

Fig.6 Switching Loss of IGBT vs. Gate Resistor -  
Inverter

图 6 IGBT 开关损耗和门极电阻-逆变器

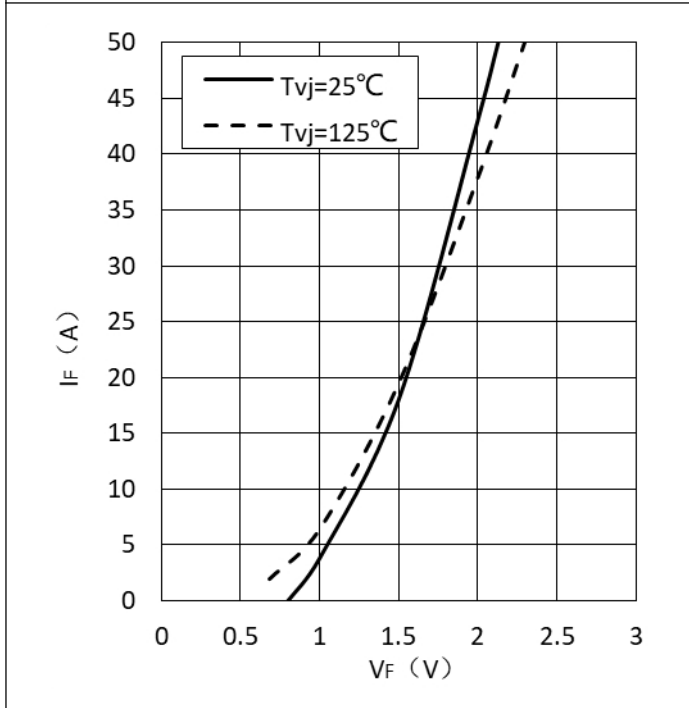

Fig.7 Typ. Forward Characteristics of Diode-Inverter

图 7 二极管正向偏压特性-逆变器

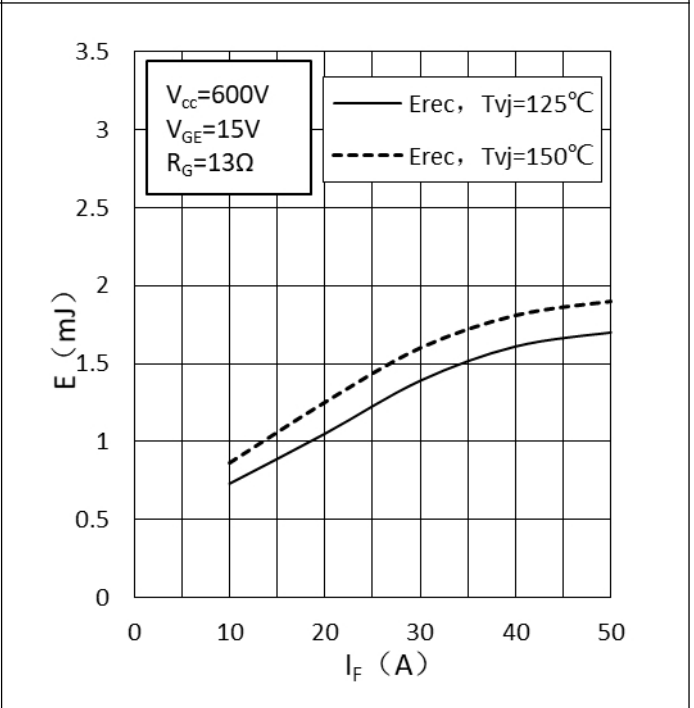

Fig.8 Typ. Switching Losses of Diode-Inverter

图 8 二极管开关损耗-逆变器

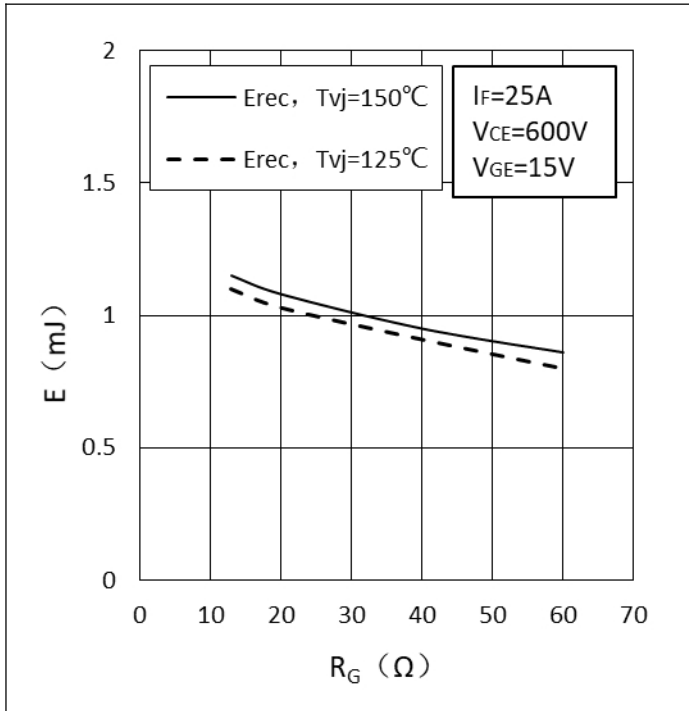

Fig.9 Switching Loss of Diode vs. Gate Resistor  
-Inverter

图 9 FRD 开关损耗和门极电阻-逆变器

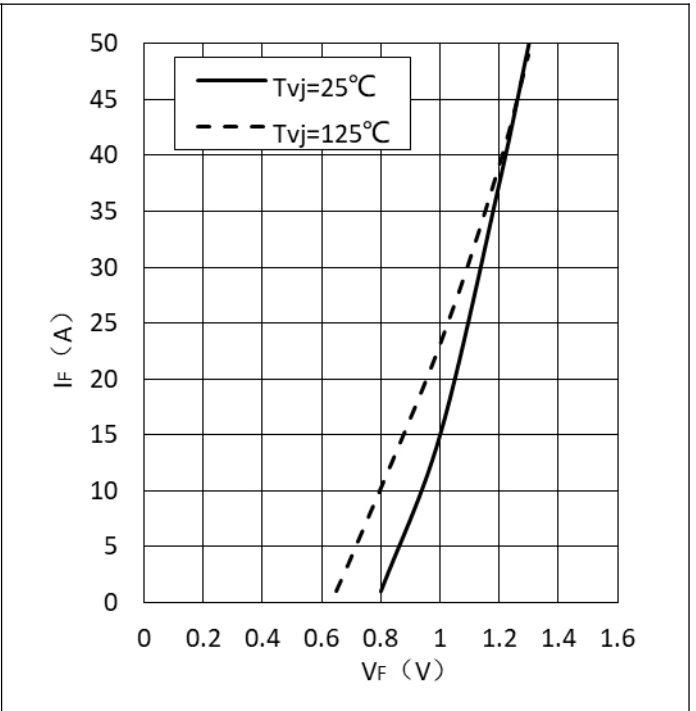

Fig.10 Forward Characteristics of Diode-Rectifier

图 10 二极管正向偏压特性-整流器

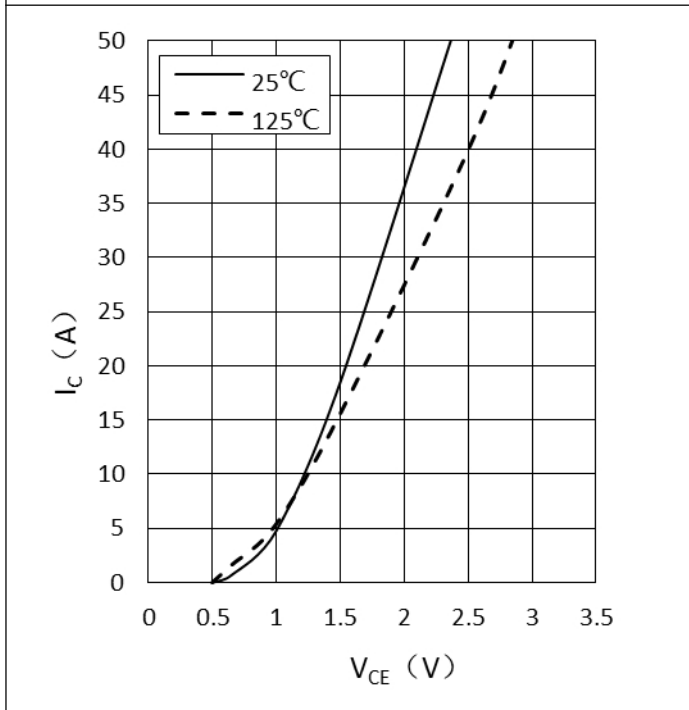

Fig.11 Typ. Output Characteristics, Brake-Chopper

图 11 输出特性, 制动-斩波器

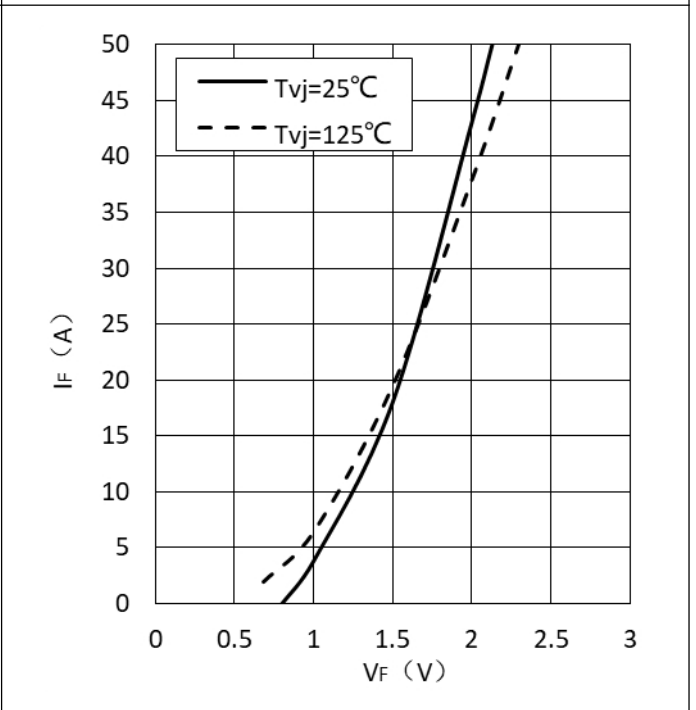
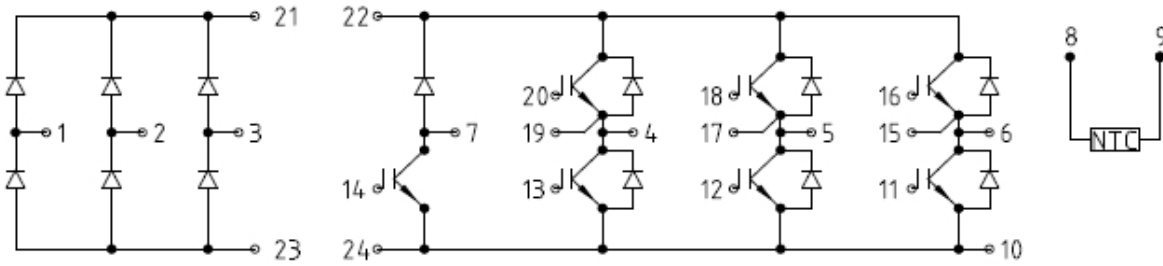

Fig. 12 Forward Characteristics of Diode-  
Brake-Chopper

图 12 二极管正向偏压特性, 制动-斩波器

● **Circuit Diagram/接线图**



□ **Package outlines/封装尺寸**

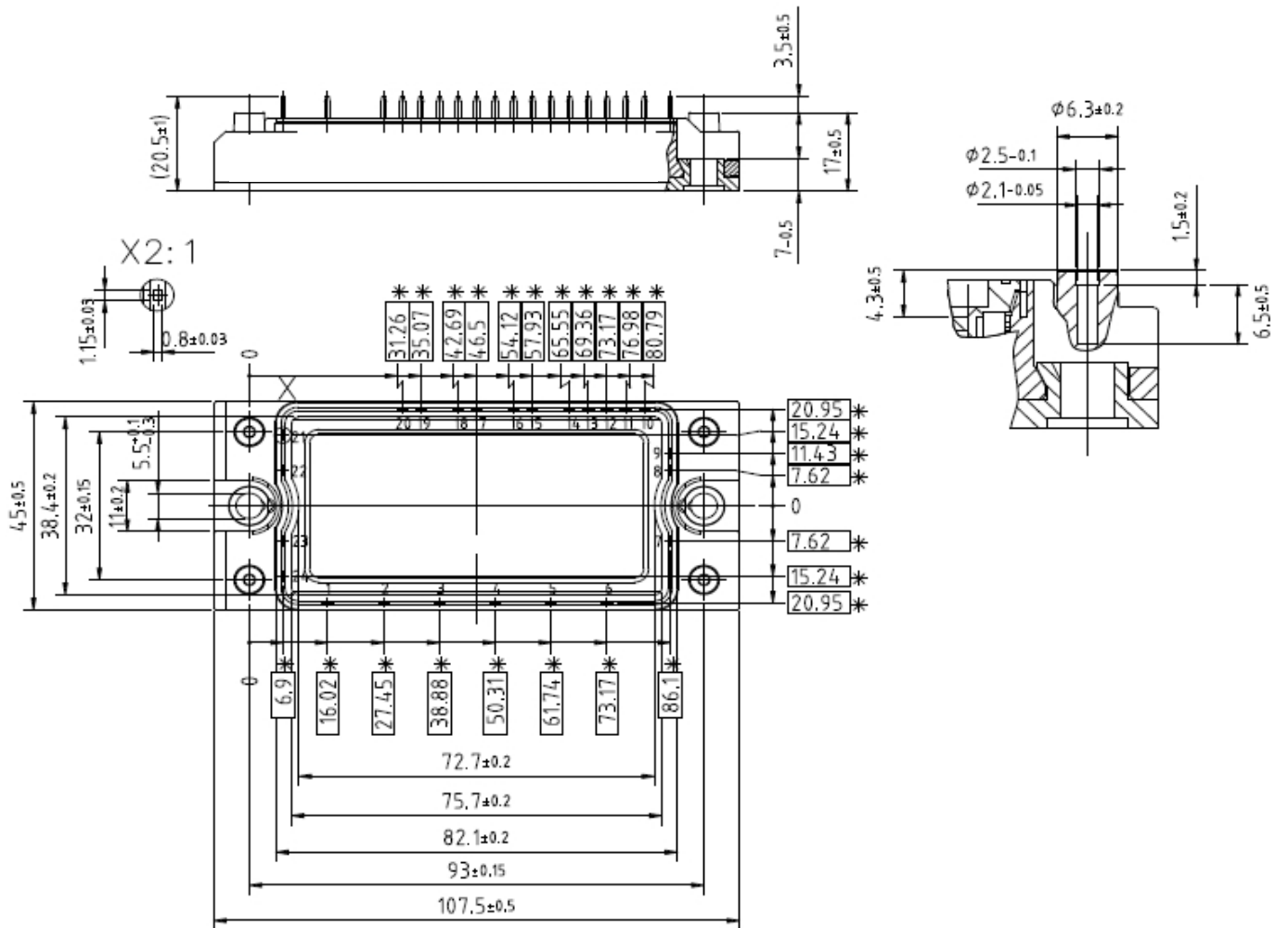

## ☐ Attention

### Correct and Safety Use of Power Module

• Unsuitable operation (such as electrical, mechanical stress and so on) may lead to damage of power modules. Please pay attention to the following descriptions and use BYD's IGBT modules according to the guidance.

### During Transit:

- Tossing or dropping of a carton may damage devices inside.
- If a device gets wet with water, malfunctioning and failure may result. Special care should be taken during rain or snow to prevent the devices from getting wet.

### Storage:

• The temperature and humidity of the storage place should be 5~35°C and 45~75% respectively. The performance and reliability of devices may be jeopardized if devices are stored in an environment far above or below the range indicated above.

### Prolonged Storage:

• When storing devices more than one year, dehumidifying measures should be provided for the storage place. When using devices after a long period of storage, make sure to check the exterior of the devices is free from scratches, dirt, rust, and so on.

### Operating Environment:

• Devices should not be exposed to water, organic solvents, corrosive gases, explosive gases, fine particles, or corrosive agents, since any of those can lead to a serious accident.

### Anti-electrostatic Measures:

• Following precautions should be taken for gated devices to prevent static buildup which could damage the devices.

(1) Precautions against the device rupture caused by static electricity

Static electricity of human bodies and cartons and/or excessive voltage applied across the gate to emitter may damage and rupture devices. Sense-emitter and temperature-sensor are also vulnerable to excessive voltage. The basis of anti-electrostatic is suppression of build-up and quick dissipation of the charged electricity.

\* Containers that are susceptible to static electricity should not be used for transit or for storage.

\* Signal terminals to emitter should be always shorted with a carbon cloth or the like until right before a module is used. Never touch the signal terminals with bare hands.

\* Always ground the equipment and your body during installation (after removing a carbon cloth or the like. It is advisable to cover the workstation and its surrounding floor with conductive mats and ground them.

\* Use soldering irons with grounded tips.

BYD Semiconductor Co., Ltd. (short for BYD) exerts the greatest possible effort to ensure high quality and reliability. Nevertheless, semiconductor devices in general can malfunction or fail due to their inherent electrical sensitivity and vulnerability to physical stress. It is the responsibility of the buyer, when utilizing BYD products, to comply with the standards of safety in making a safe design for the entire system, including redundancy, fire-prevention measures, and malfunction prevention, to prevent any accidents, fires, or community damage that may ensue. In developing your designs, please ensure that BYD products are used within specified operating ranges as set forth in the most recent BYD products specifications.

## □ 警示

### 功率模块安全正确的使用方法:

• 不当的操作（如电应力、机械应力等）可能导致模块损毁。请注意以下介绍，并根据指导来使用使用比亚迪IGBT模块。

### 运输过程中:

- 包装箱颠簸或坠落可能导致内部器件损毁。
- 器件遇水受潮将导致故障失效。在雨雪天气尤其要注意保护器件防止淋湿。

### 贮存:

• 贮存地点温度与湿度应分别控制在5~35°C和45~75%。如果贮存环境远高于或低于指示的变化范围，将危害器件的性能与可靠性。

### 长期贮存:

• 当存储器件时间超过一年，贮存地点应当采取去湿措施。器件经过长期存放使用时，检查器件确保外观没有刮伤，灰尘，锈迹等。

### 应用环境:

• 器件不应当暴露在水，有机溶剂，腐蚀性气体、易燃易爆性气体，微尘，腐蚀性药剂中，上述任何一种情况都会导致严重事故。

### 防静电措施:

• 带栅极器件应采取以下预警来防止可以损毁器件的静电生成。

(1) 预防措施可以防止静电击穿器件。

- \* 门极与发射极间产生的人体静电、包装箱静电和过电压将损毁或击穿器件。采样发射极和温度传感器同样容易受到过压损毁。防静电底板可以抑制电荷生成并快速耗散。
- \* 不要用易受静电影响的容器运输或贮存器件。
- \* 发射极信号端子应一直用碳纤维布或类似物短接直到模块使用前。任何情况下不要徒手碰触信号端子。
- \* 安装过程中始终保持设备和你的身体接地(移除碳纤维布或类似物后)。用导电垫覆盖工作地点及周围地板并使其接地。
- \* 使用接地的烙铁头。

比亚迪半导体股份有限公司(简称BYD)致力于产品的高性能和高可靠性。然而，半导体器件一般会因为其固有的对电荷敏感性和易受物理应力损坏的特点，而发生故障和失效。当用户购买BYD的产品时，用户有责任按照安全标准来为整个系统做出安全的设计来防止任何事故，火灾或继而引起的危害公共安全，包括设计的冗余，防火措施，故障预防。请改善您的设计，确保BYD的产品在额定范围内使用并参考最新的BYD产品规格书。